

Unit 1 Teacher's uniform

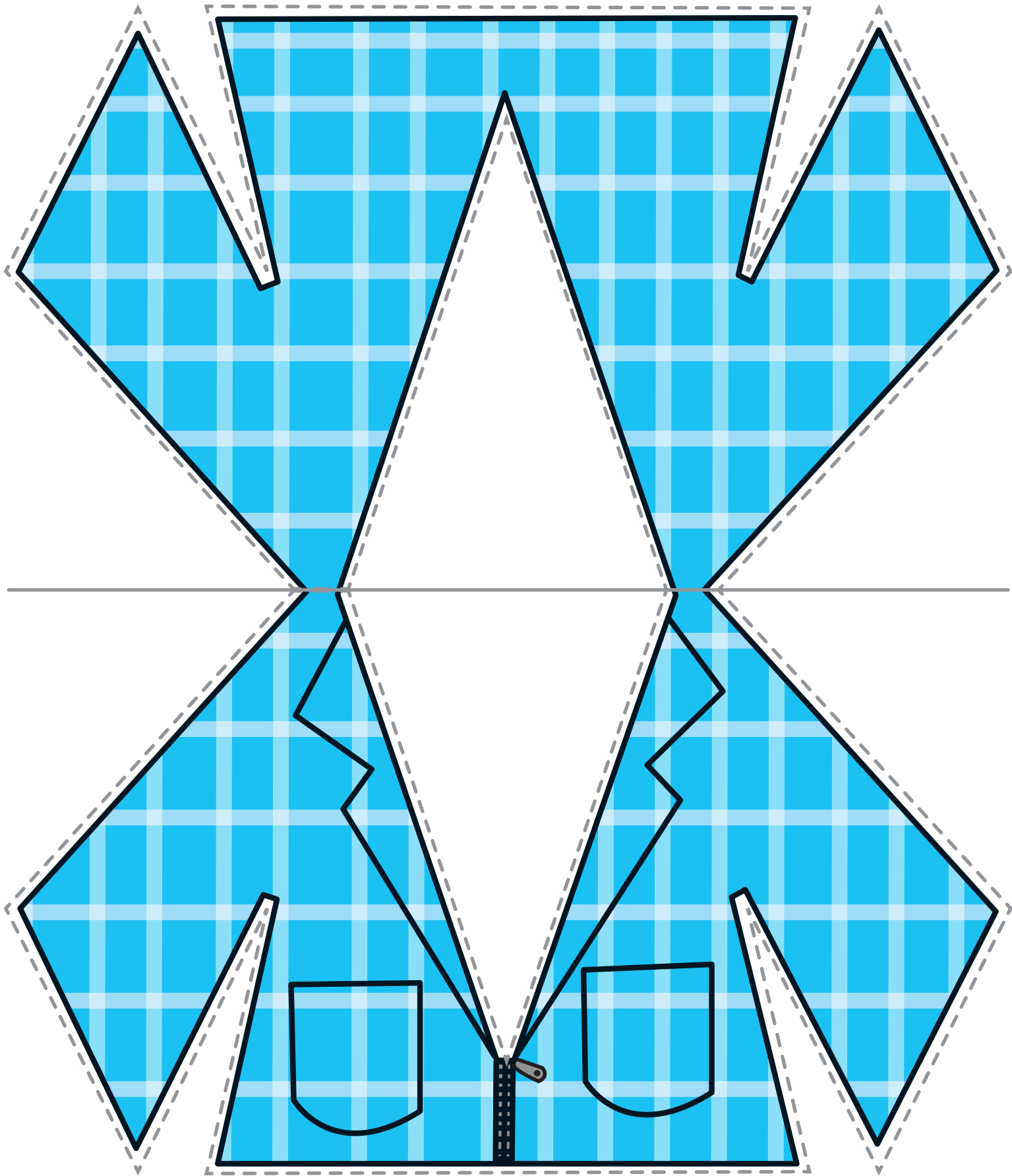

Make a teacher's uniform for Mouse. Fold paper in half and cut out while folded. Place over Mouse's head and stick the sleeves together to secure.

Unit 2 Dancer's flower

Make a flower for Mouse, similar to Daisy's flower in the story.

Cut out both pieces. Wrap the band around one of Mouse's ears and stick together at the ends so it fits around the bottom of his ear. Then stick the flower onto the band. You may wish to strengthen the flower by mounting it on cardboard first.

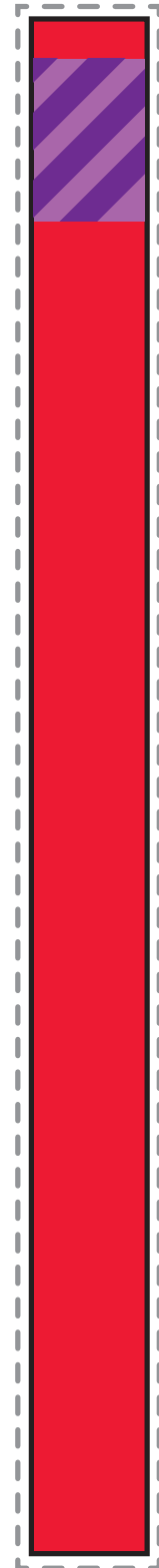
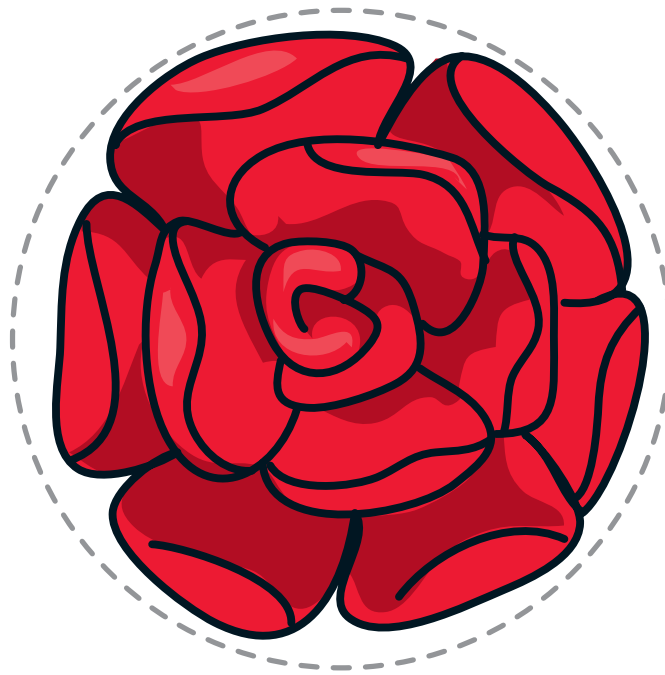

Unit 3 Pilot's wings

Make a pilot's wings badge for Mouse. Cut out the badge, then attach to Mouse with tape, or a safety pin. You may wish to strengthen the prop by mounting it on cardboard first.

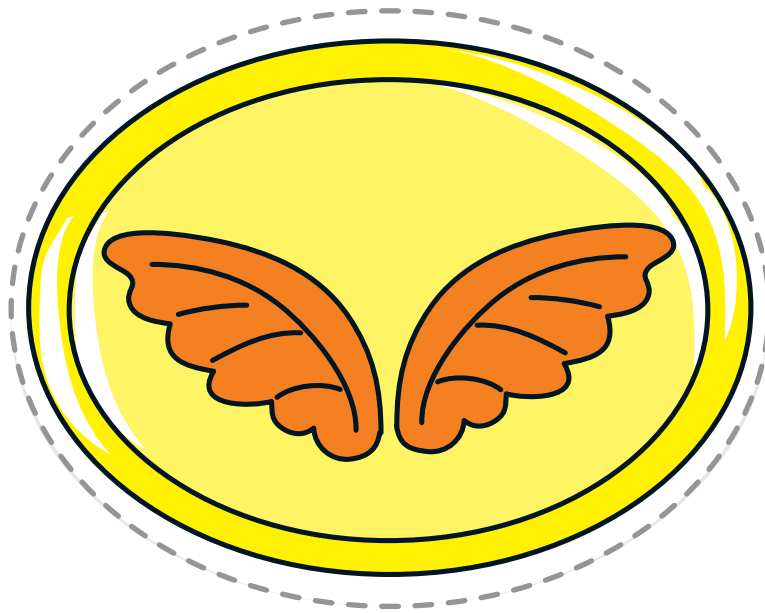

Unit 4 Builder's tool

Make a builder's tool for Mouse. Cut out and secure the wrist strap around Mouse's wrist using glue or tape. You may wish to strengthen the tool prop by mounting it on cardboard first.

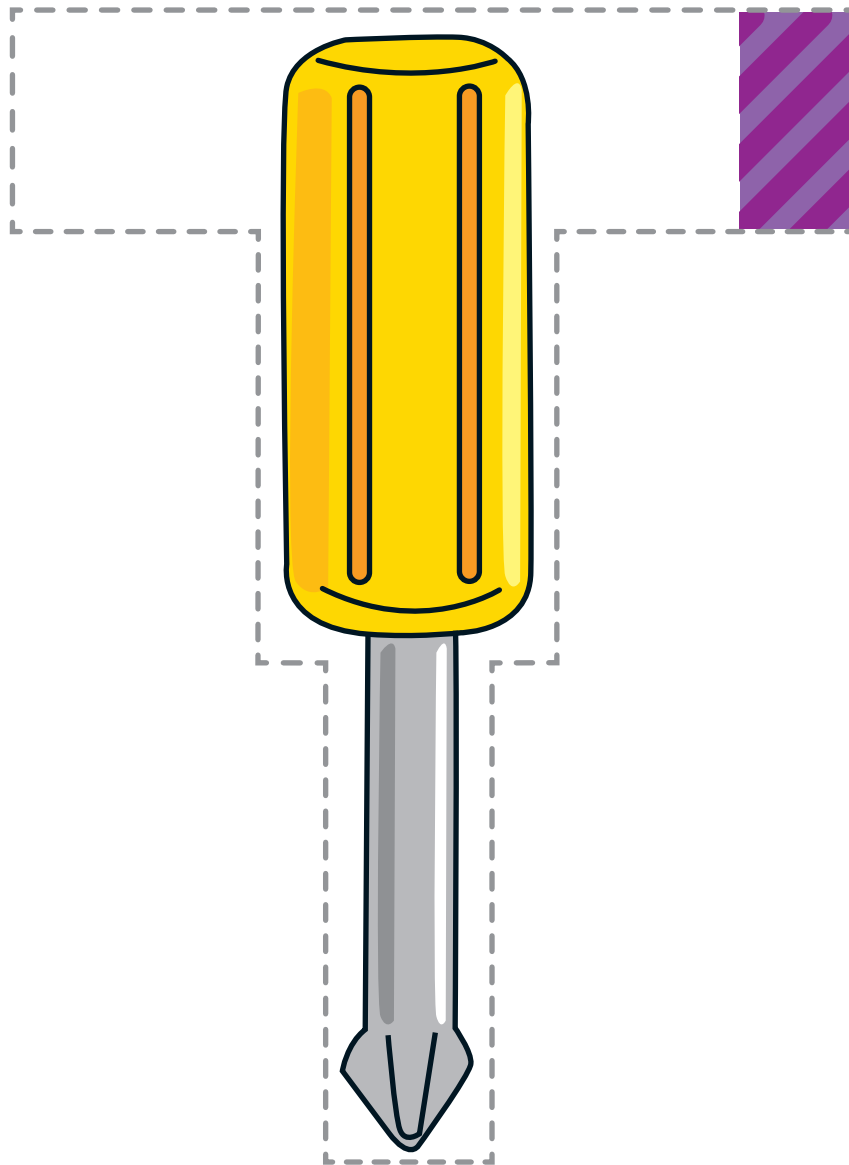

Unit 5 Farmer's gloves

Make farmer's gloves for Mouse. Cut out the two gloves, then fold in half at the finger end. Place on Mouse's hands. Then stick together using the straps at the bottom of the gloves, wrapping around Mouse's wrist. You may also wish to stick the sides of the gloves together, but they will work well with only the wrist straps secured.

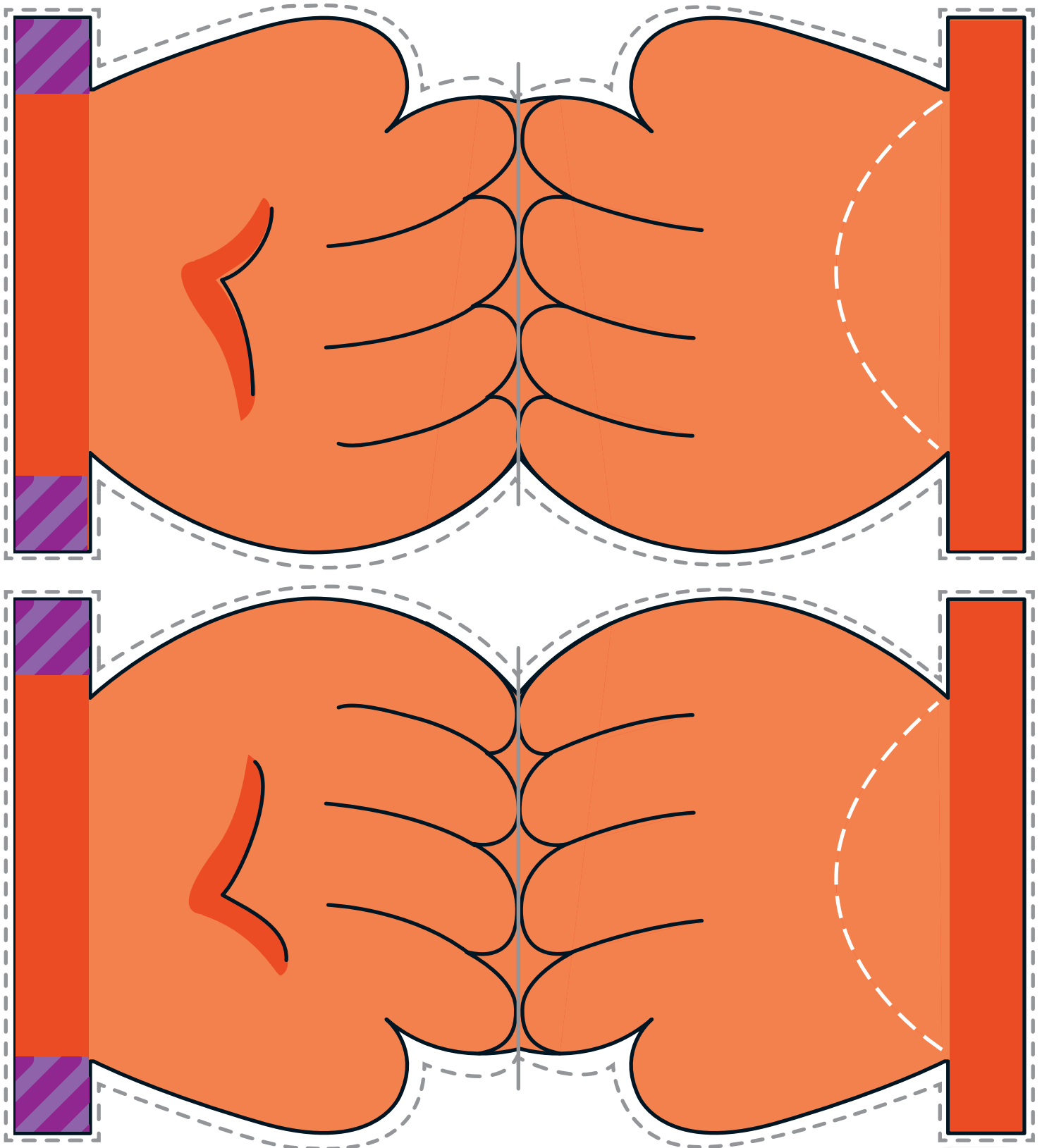

Unit 6 Sailor's life jacket

Make a life jacket for Mouse. Fold the paper in half, then cut out while folded. Place over Mouse's head. You may wish to secure the sides with glue, but it should work well left open.

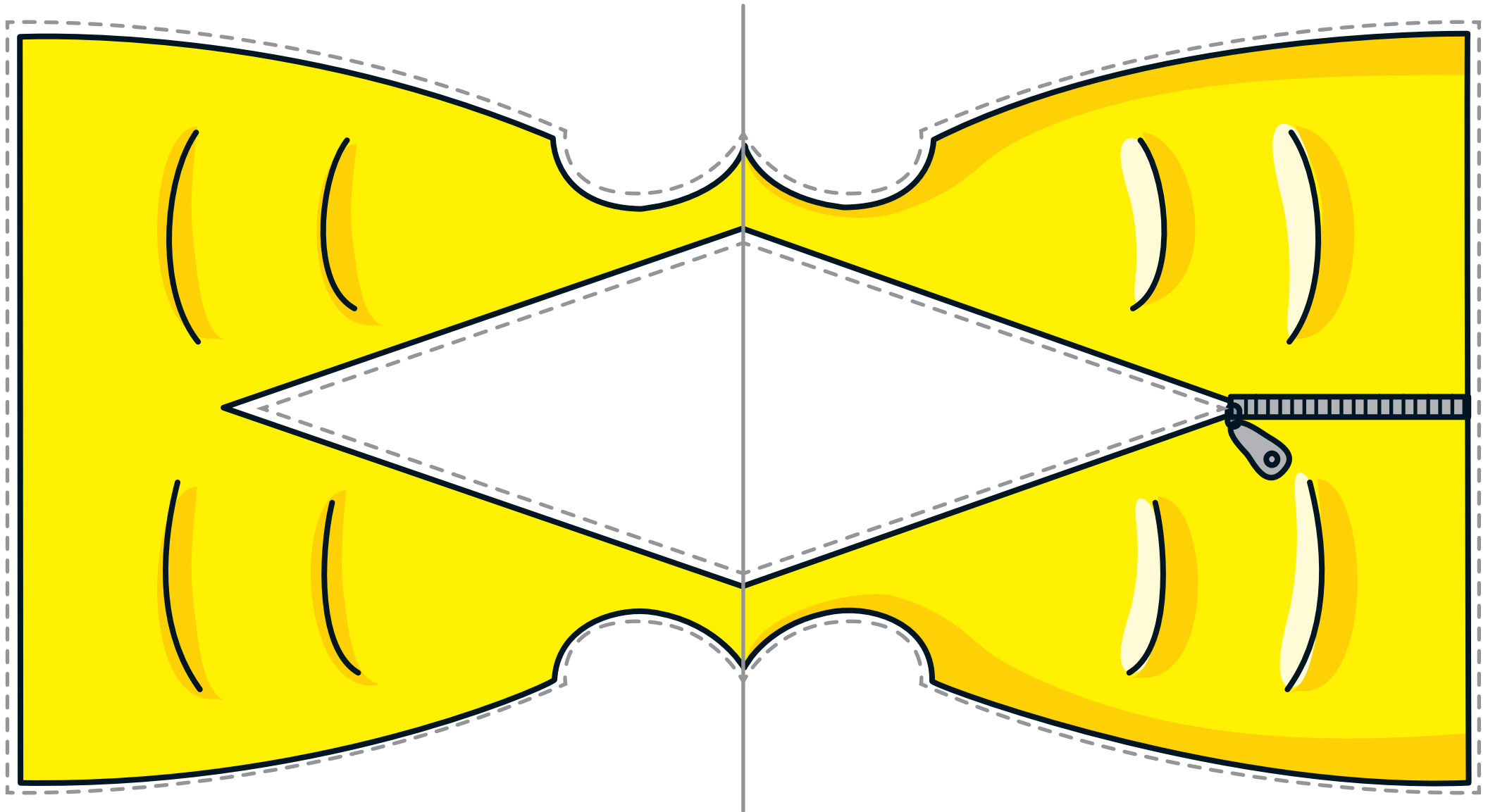

Unit 7 Chef's apron

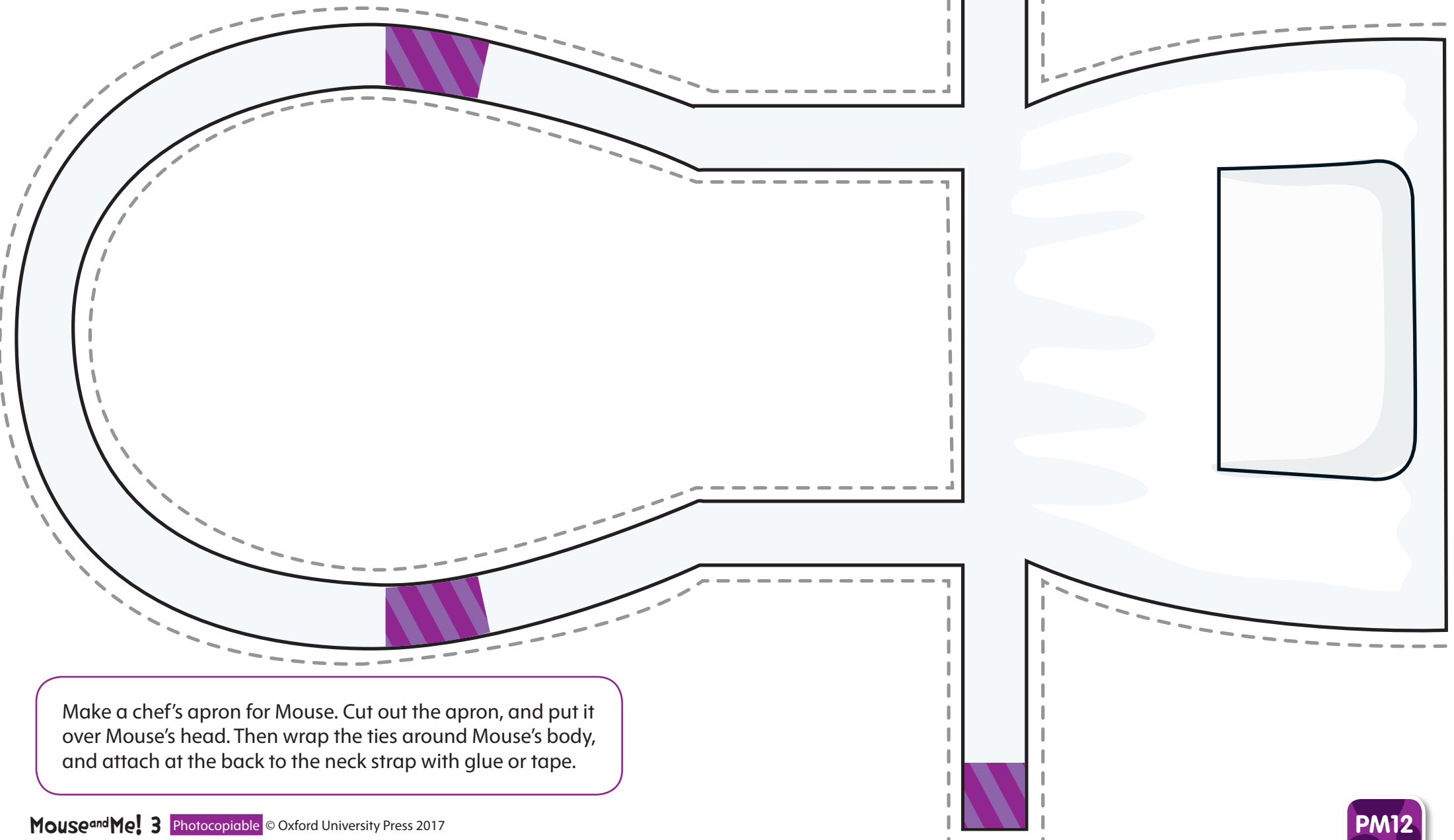

Make a chef's apron for Mouse. Cut out the apron, and put it over Mouse's head. Then wrap the ties around Mouse's body, and attach at the back to the neck strap with glue or tape.

Unit 8 Gardener's tool

Make a gardener's tool for Mouse. Cut out and secure the wrist strap around Mouse's wrist using glue or tape. You may wish to strengthen the tool by mounting it on cardboard first.

